



印策（上海）贸易有限公司
INCHO (SHANGHAI) TRADING CO., LTD



Pile Turner Machine



I、Device name&Model :Pile Turner Machine FZ-1200

II、General View

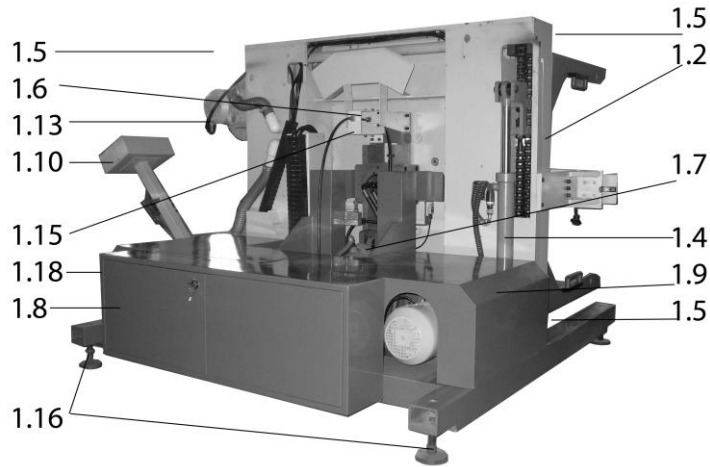
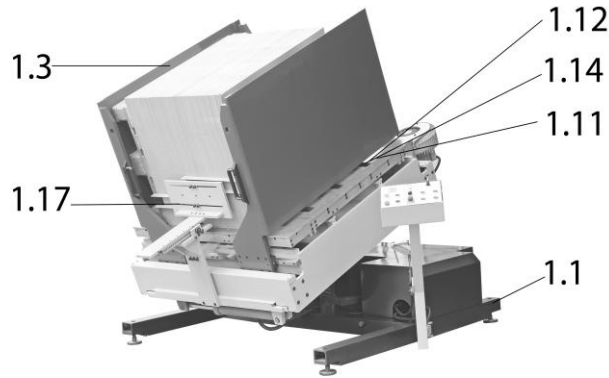

- 1.1 Base
1.2 frame
1.3 Platforms
1.4 Clamping Cylinder for the Driver for the Platforms
1.5 Chain wheels
1.6 Pivot bearing
1.7 Tilting cylinder
1.8 Control cabinet
1.9 Hydraulics
1.10 Control panel
1.11 Ventilation plate
1.12 Aerating device
1.13 Blower motor
1.14 Ventilation system
1.15 Locking mechanism
1.16 Levelling feet
1.17 Jogging ruler
1.18 Main Switch



III、Specification

Technical Data:

Max. weight of a stack(including pallets)	1000KG
Paper format	Max. 800×1200MM Min. 360×560MM
Width between the platforms	Min. 680MM Max. 1440MM

Electrical data:

Voltage:	3P 400V AC 50HZ	
Capacity	1 Fan	2 Fans
With ventilation/aeration system	5.9KW	9.6KW
With ventilation and jogging system	6.3KW	10KW

Hydraulics:

Pressure	Max. 16MPA	
Hydraulic oil	Summer 46#	Winter 32#
Hydraulic oil tank capacity	12 Litre	

Dimensions:

Machine,excluding packing	2500KG
Machine	2370×2090×1890MM
Operating space	3700×3400×2000MM
Noise	<70db
Ambient Conditions	
Temperature	-15℃~+50℃
Temperature	Dry, roof over
	Relative humidity no more than 80%

IV、Features

1.Dust removing

Before printing, the paper fibers, paper scraps and dusts will be removed to improve the printing quality and lower the rejection rate. By the way, it can stop the dusts into the printing machine to increase the service life of printing machine.

After printing, removing printing power, speeding the ink drying, separating papers and dirty in back paper can be achieved.

2.Separation of paper

After the vibration and air jetting, the pile is filled with air cushion between of the sheets, in this way, mis-feeds can be avoided.

3.Aligning

With the vibration platform and high pressure blower, the whole pile paper can be aligned at one time.

4.Static remove(optional)

Air with ionized air reduces the electrostatic charge which may affect the finishing process of coated and printed paper or plastic foil.

5.Odor Neutralizing



Very important for food packaging

6. Turning

For the piles of double-sided printing paper, the pile turning will improve the work efficiency and lower the intensity of work. The working environment will be much better for workers.

7. High efficiency easy operation









For average, the turning, powder removing, separation of paper and aligning, the processes takes about 4-5 minutes.

Everyone can handle the machine.











V、Function:

This machine contains three functions: turning, jogging and ventilation. The machine is necessary auxiliary equipment in the printing process, it not only make the paper stack turned over automatically, but also make the stack tidy. Importantly it can save in labors and avoid impact on the printed surface.

VI、Complete work cycle

1. The stack of product which is to be turned lies between two pallets. The stack is placed on the bottom platform and is arranged so that the pallets touch the ventilation plate and one edge of the stack touches the adjustable ruler.
2. When the hydraulics button  is pressed and the control lever  is shifted the platforms move together and thus clamp the stack with the pallets between the platforms.
3. When the hydraulics button  is pressed and the control lever  is shifted, the fork housing tips back 90°. The sheets of paper then point vertically upwards.
4. The locking mechanism of the pivot bearing is released when the locking lever is actuated.
5. The fork housing is then turned 90° in the horizontal, either left or right, by hand. When the fork housing is in the 90° position, actuate the locking lever again to engage the 90° locking mechanism. The adjustable ruler must now point to the front.
6. Press the hydraulics button  and shift the control lever  to tilt the fork housing, so that the stack of product rests against the adjustable ruler.
7. Press the hydraulics button  and shift the control lever  to slightly open the platforms so that the stack can be aerated.
8. The potentiometer ventilation time is used to preset the required



- ventilation duration.
9. The aeration system (and thus the automatic machine cycle) is started with the preset aeration time by pressing the green air on button . The air nozzles move back and forth behind the ventilation plate.
 10. Press the green jogging on button  to switch on the jogging system.
 11. When the pile of product has been jogged enough so that it is properly aligned, or when the preset aeration time has elapsed, the jogging system is switch off automatically.
 12. When the hydraulics button  is pressed and the control lever  is shifted, the platforms close again and clamp the aligned layers of product between the pallets.
 13. Press the hydraulics button  and shift the control lever  to return the fork housing to its horizontal position.
 14. The fork housing is now turned another 90° by hand in its horizontal position to either the 0° or the 180° position.
 15. Press the hydraulics button  and shift the control lever  to tip the fork housing back 90° into the vertical position.
 16. Press the hydraulics button  and shift the control lever  to fully open the platforms. The bottom platform comes to rest on the floor. The pallet which was originally on the top of the stack at the beginning of the turning operation is now at the bottom and the bottom pallet is now at the top. The printed side of the stack has thus been turned.
 17. The turned stack can be removed from the machine.

VII、Warranty

The machine warranty is for one year, we free offer the parts which are normal operation of the damage not including man-made damage except consumables during the guarantee period.

VIII、Price

machine	Model	unit	number	FOB price
Pile turner machine	FZ1200	set	1	

Packing: 2500×2150MM with pallet

Rough weight: 2500kg



IX、Flow chart

Operation Processes

1. Turning the pile into platform of pile turner with hydraulic trolley



2. Turning up, rotating, tilting



3. Airing and jogging to remove dust(remove paper fiber, paper scrap and dust), separation paper, aligning paper, and turning paper



4. Turning up, turning down, and pull out by hydraulic trolley

